



Tuning the Hydra

Calibrated Downhaul System

1) To set your downhaul:

a) Use the correct Ezzy mast combination and check that the length of your mast falls within the recommended length (chart 1). See “Troubleshooting” if your Ezzy mast combination does not match with the lengths in Chart 1.

b) Downhaul your sail until the calibration mark lines up with the bottom of the mast (figure 1).

Which Calibration Line to Use?

- Powered up: use the MAX line.
- Medium powered: use the MED line.
- Under-powered, use the MIN line.

Additional Information:

- We have set the adjustable head cap to the correct setting. **Do not re-adjust the head webbing.**

- If you feel back-hand pressure, apply more outhaul.

- If you are foiling, set your sail flatter, with more outhaul and downhaul.

- To get the best performance, adjust the downhaul and outhaul together. For example, if you increase the downhaul for strong wind, you should also increase the outhaul. And, for light wind, to get maximum power, reduce the outhaul as well as the downhaul.

-The Hydra has been designed to ALWAYS have a fold of material extending along the luff from the #2 batten down to the foot batten.

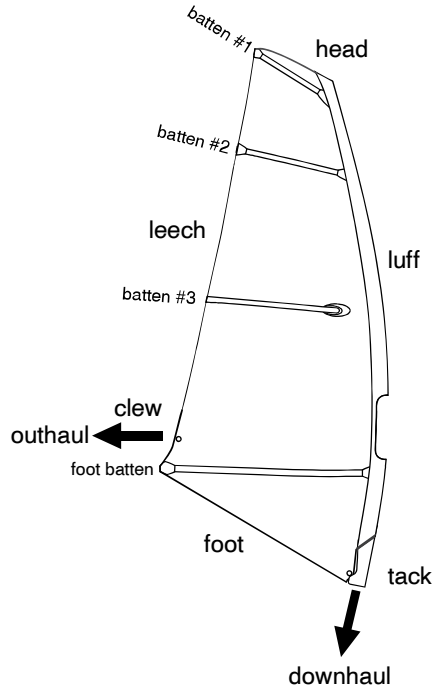

| | Mast Combination | | Total Length (with tip plug) |
|-----|------------------|-------------|---------------------------------|
| | Bottom (cm) | Top (cm) | |
| 3.7 | 340 | 340 | 340.5 |
| 4.7 | 370 | 400 | 385.5 |
| 5.7 | 400 | 430 | 415.5 |
| 6.7 | 430 | 430 | 430.5 |
| 8.1 | 460 | 460 | 460.5 |

Chart 1: correct mast combinations and lengths.

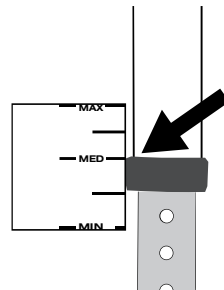

Figure 1: Downhaul until the calibration mark lines up with the bottom of the mast.

2) Setting the Downhaul if You Do Not Have the Correct Ezzy Mast:

- a) First, make sure you have **NO** outhaul.
- b) Then, downhaul until the looseness on the leech extends to the four dots printed on the upper leech of the sail (figure 2).

Note: to see the looseness, the leech at the dots must be touching the ground.

c) This is the medium wind setting.

d) Next, move the downhaul gauge at the bottom of the sail so that the medium mark of the gauge lines line up with the bottom of your mast (figure 3).

e) The downhaul gauge is now positioned correctly. From now on, to set your downhaul, just downhaul until the the gauge lines up with the bottom of your mast.

Note: When observing the looseness at the dots for this exercise, the sail must have no outhaul. When you apply outhaul the leech tightens.

Additional Information:

- See page 1 for an explanation on which line to use of the downhaul gauge.
- If you feel back-hand pressure, apply more outhaul.
- If you change to a different mast, you will need to repeat steps a) through e).

3) Tension the Tack Strap

After downhauling, thread the tack strap through the buckle and pull the strap until the foot gets tension. You will see a small wrinkle running out from the corner of the sail. Then, wrap the end of the tack strap around your mast extension and loop the end of the tack strap under itself and secure the strap with the velcro. Store your downhaul line in the mesh pocket located inside the pad (fig. 4).

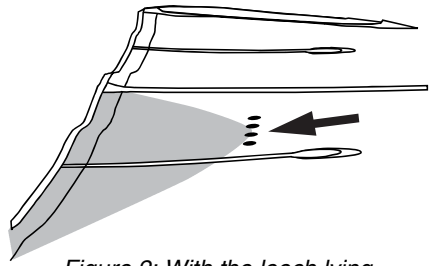

Figure 2: With the leech lying on the ground, downhaul until the looseness extends to the four dots.

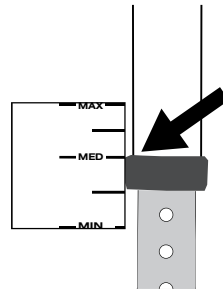

Figure 3: Downhaul until the calibration mark lines up with the bottom of the mast.

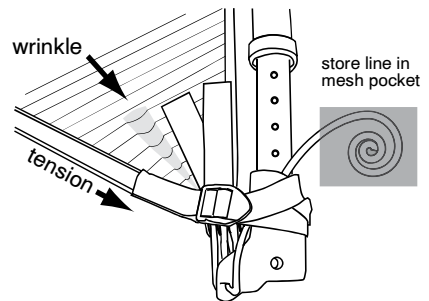

Fig. 4: Tension tack strap and store downhaul line in mesh pocket.

4) Setting the Outhaul:

The Hydra requires more positive outhaul than most sails (fig. 5).

The three cords sewn at the clew indicate how much positive outhaul is needed for varying wind conditions. The longest cord shows the maximum outhaul for strong wind; the shortest cord indicates the minimum outhaul for light wind and the middle cord shows a medium outhaul setting.

Follow these steps to set the outhaul:

- a) First, correctly set the downhaul.
- b) Next, release all outhaul tension.
- c) Make sure the battens are all rotated under the mast.
- d) Then, gently pull on the outhaul cord and set your boom to the end of the cord (fig. 6).
- e) Finally, outhaul your sail to the end of the boom (fig. 7).

Additional Information:

- When setting your boom to the cord, don't pull the clew.
- We suggest starting with the medium length cord. If you feel over-powered (back-hand pressure), increase the outhaul about 1 to 2 cm. If you feel under-powered, reduce the outhaul by about 1 to 2 cm.

5) Tensioning the battens:

Use the tensioner key that is stored in the pad of the sail and tension the battens until you eliminate any vertical wrinkles that extend out from either side of the batten pocket (figure 8).

Note: Your battens have already been tuned by us in the factory and most likely will not need further tuning. Be careful not to over-tension your battens.

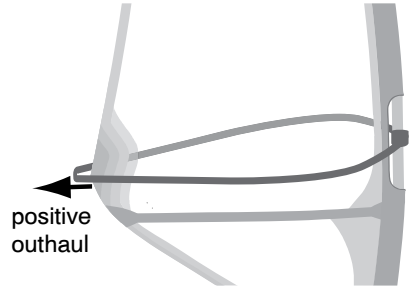

Fig. 5: Positive outhaul



Fig. 3: Adjust the boom length to the outhaul cord.

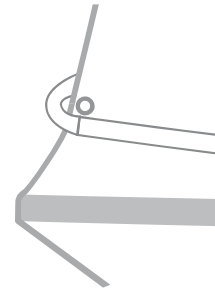

Fig. 4: Outhaul to the end of the boom.

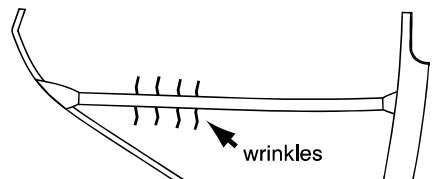

Figure 8: Tension the battens until there are no vertical wrinkles on either side of the batten pocket.

6) Sail Care:

- Creasing damages the sail cloth. Avoid creasing your sail when rigging and de-rigging.
- Sunlight kills all sail cloth. Keep your sail out of the sun when not sailing.
- Don't rig on sharp objects.
- After rolling the sail, tuck the pad so it rests along the sail, wrap the tack strap around the pad and the sail, then attach the velcro (fig. 9).
- Insert your sail sleeve-end first into the sail bag (fig. 10).
- It is better to store your sail in a horizontal position, rather than vertically.
- Don't store your sail when it is wet with fresh water. This can cause mold or mildew to grow.

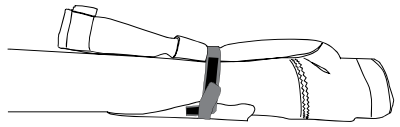

Fig. 9: After rolling, tuck the pad, then wrap with the tack strap and secure the velcro.

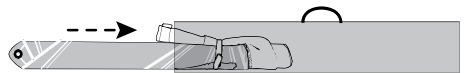

Fig. 10: Insert with the sleeve-end first into the sail bag and store horizontal.

7) Troubleshooting:

> I am using the correct Ezzy mast combination, but my mast is 3.0mm longer than the lengths listed on your chart, what should I do?

a) Remove the downhaul gauge from the sail and re-attach it 3.0mm **lower**.

> My Ezzy mast is 3.0mm shorter than the lengths listed on your chart, what should I do?

a) Move the downhaul gauge **up** by 3.0mm.

> My sail has too much back-hand pressure.

- a) Apply more outhaul.
- b) Reduce downhaul.

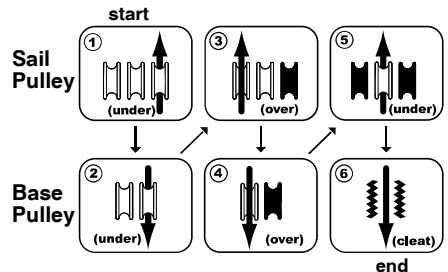

Fig. 11: Threading the tack pulley for a Chinook-style extension.