



# INFINITY

## RIGGING GUIDE

### Note:

Before rigging your Infinity for the first time, you must adjust the cams to fit your mast. Please refer to the guide titled "Custom Fit Your Cams To Your Mast".

## Rigging Steps 1 to 10:

**1) SLIDE MAST IN ABOVE CAMS:** lay your sail on the ground and insert your mast into the mast sleeve, sliding the mast ABOVE the cams.

**2) CHECK ADJUSTABLE HEAD:** once the mast has reached the top of the sail, walk up to check that the mast tip is properly seated in the head cap. Also check to make sure that the adjustable head is set to its shortest setting.

**3) THE INITIAL DOWNHAUL:** attach your downhaul line, but DO NOT TENSION IT YET.

**4) THE INITIAL OUTHAUL:** refer to your sail's boom specifications located at the tack and outhaul to the maximum boom length. There are two clew grommet positions, we suggest using the lower grommet.

**5) POP CAMS ONTO THE MAST:** open the velcro slots at the cam and pop the cams onto the mast. Do this by pushing down on the batten while lifting the cam onto the mast (diagram 1).  
**Note: If you have difficulty getting the cams onto the mast, make sure you have no downhaul tension and that you have your sail outhauled flat.**

**6) FINAL DOWNHAUL:** downhaul your sail until the sailcloth on the upper leech goes slack between battens #2 and #3. Use the three colored bars that are printed between battens #2 and #3 as your downhaul indicator (diagram 2). For light wind, downhaul until the looseness extends to the black bar. For medium wind, the looseness should extend to the red bar and for high wind, downhaul until the looseness extends to the white bar. **Note:** the upper leech needs to be on the ground to see the looseness.

Don't over-downhaul. The looseness on the leech should never extend in front of the printed white bar between battens #2 and #3. If you are over-powered, apply more outhaul.

**7) FINAL OUTHAUL:** first, take note which color bar you are downhauled to between battens #2 and #3, then release ALL outhaul tension while making sure the battens and cams are all flipped the same way and the cams are fully rotated. This is your starting point at zero outhaul. Next, choose the correct outhaul cord that matches the downhaul indicator color bar shown in diagram 2. Then hold the guide cord out and adjust your boom to the end of the guide cord (diagram 3a). Finally, outhaul the sail all the way to the end of the boom (diagram 3b).

Always match your outhaul to your downhaul. That means for light wind use the black bar on the leech between battens #2 and #3 with the black outhaul cord, for medium wind, the red bar on the leech with the red outhaul cord and for high wind, the white bar on the leech with the white outhaul cord.

**8) CHECK THE BATTEN TENSION:** when correctly tensioned, there should be no wrinkles running across the batten pockets. If the battens need adjusting, use the screwdriver key that is stored at the tack of your sail and tighten the battens until the wrinkles through the batten pocket disappear. **WARNING: OVER-TENSIONING THE BATTENS COULD DAMAGE THE SAIL.**

Note: You only need to check your batten tension the first or second time rigging.

**9) TACK STRAP:** Wrap your downhaul line around the mast base. Tension the tack strap until you get a small wrinkle running out from the corner, then wrap the tack strap over the downhaul line and loop it under itself (see diagram 4).

**10) CLOSE CAM OPENINGS:** close the velcro openings at the cams.

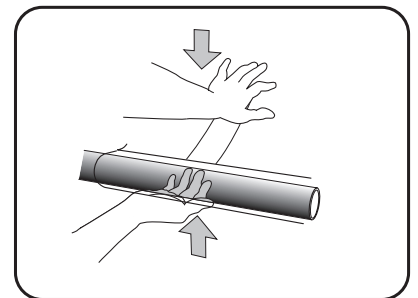
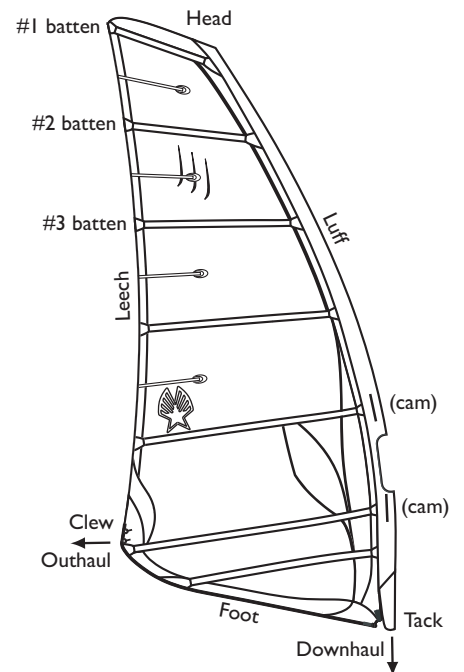

diagram 1  
popping cams onto mast

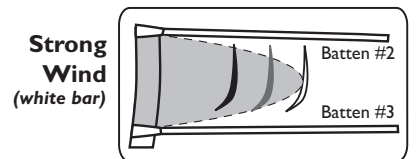
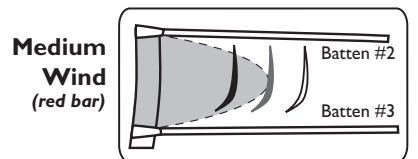
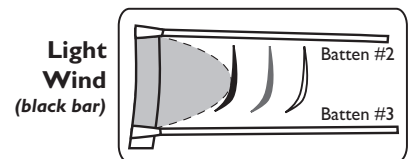

diagram 2  
Downhaul settings

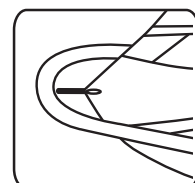

diagram 3a

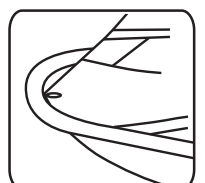

diagram 3b

1) Set the boom length by matching the cord color to the printed upper leech bar color.

2) Outhaul to the end of the boom.

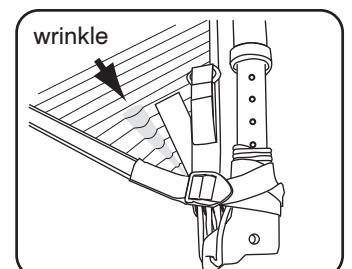

diagram 4  
Tension Tack Strap

## De-rigging:

- 1) Outhaul sail flat.
- 2) Un-thread the tack strap and unfasten the mast pad velcro.
- 3) Release downhaul completely.
- 4) Open the velcro openings at the cams and allow the sleeve to slide up the mast.
- 5) Wiggle the cams back and forth to loosen them on the mast, then pop the cams off the mast.
- 6) Spin the mast while slowly pulling it out of the sleeve.
- 7) Roll the sail beginning from the head. After rolling, tuck the mast pad along the sail, then wrap the tack strap around the pad and sail, then fasten the velcro (see diagram 5).
- 8) Insert the sail into the sail bag with the SLEEVE-END first (diagram 6).

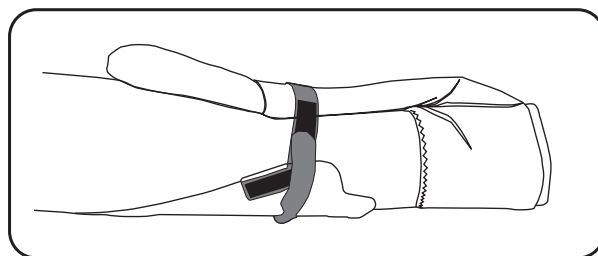

diagram 5  
Wrap the tack strap around the pad and sail.

## Using Your Infinity Without the Cams:

You can use your Infinity with both cams, with a single cam or with no cams. To remove the cam the sail should be unrigged. Open the velcro slots and remove the cam and the cam pocket. Close the slots and you are ready to rig.

## Sail Care:

- 1) **Sunlight** will break down all sailcloth in a relatively short time (300 hours of direct sunlight). Don't dry off your sails in the sun!
- 2) **Creasing** damages sail cloth. When rigging and de-rigging, try not to crease your sail or let it flap in the wind.
- 3) **Sand** will scratch the sailcloth and can clog the batten tensioners. Try to roll your sail sand-free.
- 4) **Cleaning:** Use a mild soap and water with a rag to clean your sail. Harsh solvents may damage the sail cloth. Contrary to what most people think, you do not need to fresh-water rinse your sail.
- 5) **Storage:** It will not damage your sail to store it with the battens fully tensioned. If you are storing your rolled sail vertically, make sure the sleeve-end of the rolled sail is supporting the weight. This prevents the clew from getting damaged.

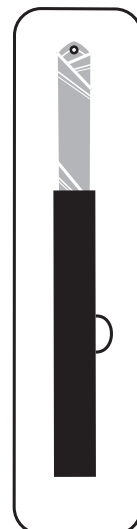

diagram 6

To avoid damaging your sail, insert the sleeve-end first into the bag.

## Problem Solving:

### It is difficult to pop the cams onto the mast when rigging.

- 1) Cam pocket may be too short or you may have the wrong cam inserted.  
Refer to guide titled "Custom Fitting Your Ezzy Cams To Your Mast", or
- 2) Make sure you have no downhaul tension, or
- 3) Make sure you have your sail outhauled flat.

### If you can't close the velcro openings on the mast sleeve.

Your Cam Pocket is too short.

### The sleeve is too loose around the cam.

Your Cam Pocket is too long.

### If your sail feels too powerful.

- 1) Sail is too deep: try more downhaul and outhaul, or
- 2) Mast is too stiff: check that you are using the correct mast.

### If your sail lacks power.

- 1) Sail is too flat: try less downhaul and less outhaul, or
- 2) Mast is too soft: check that you are using the correct mast.

### If your sail pulls too much on your back arm.

- 1) Need less downhaul, or
- 2) Need more outhaul, or
- 3) Harness lines need to move back, or
- 4) Move your universal further forward on your board.

### If your sail pulls too much on your front arm.

- 1) Need more downhaul, or
- 2) Need less outhaul, or
- 3) Harness lines need to move forward, or
- 4) Move your universal further back on your board.

### How can you "soften" your cam rotation?

- 1) The fuller your sail is set, the "harder" the cam rotation will be. Applying more downhaul and outhaul will give a softer cam rotation.
- 2) Using one size longer cam pocket will also soften the rotation.

	430	460	490
6.0	x		
6.5		x	
7.0		x	
7.5		x	
8.5			x
9.5			x

x = great combination  
■ = good combination

Suggested Masts